



TYPICAL MOTOR PERFORMANCE DATA

Model: MNET07X52A2TBR

Serie: NEMA Elite

Issued Date	11/14/2022	Doc. #	390-R0
Issued By	LD	Issued Rev	0

HP	kW	Pole	FL RPM	Frame	Voltage	Hz	Phase	FL Amps
7.50	5.50	2	3500	213T	230/460	60	3	18/9
Enclosure	IP	Ins. Class	S.F.	Duty	Nom. Eff.	Nema Design	kVA Code	Ambient Temp. (°C)
TEFC	55	F (*)	1.15	CONT	89.5	B	H	40 C

* Inverter Duty

Load	HP	kW	Amperes	Efficiency (%)	Power Factor (%)
Full Load	7.50	5.50	9.0	90.1	88.5
¾ Load	5.63	4.20	6.8	89.8	86.1
½ Load	3.75	2.80	5.0	88.0	79.6
¼ Load	1.88	1.40	3.5	80.6	60.7
No Load			2.4		9.2
Locked Rotor			60.0		45.7

Torque				Rotor Inertia
Full Load (lb-ft)	Locked Rotor (% FLT)	Pull Up (% FLT)	Break Down (% FLT)	(lb-ft²)
11.30	230.0	215.0	320.0	0.46

Safe Stall Time(s) Cold / Hot	Sound Pressure dB(A) @ 1M	Bearings*		Approx. Motor Weight (lbs)
		DE	NDE	
19.9 / 11.2	-	6308ZC3	6308ZC3	168

*Bearings are the only recommended spare part(s).

Included Accessories:

All characteristics are average expected values.

Engineering		Doc. Written By		Doc.# / Rev	MNET07X52A2TBR
Engr. Date		Doc. Approved By		Doc. Issued	



SPEED TORQUE/CURRENT CURVE

Model: MNET07X52A2TBR

Serie: NEMA Elite

Issued Date	11/14/2022	Doc. #	390-R0
Issued By	LD	Issued Rev	0

HP	kW	Pole	FL RPM	Frame	Voltage	Hz	Phase	FL Amps
7.50	5.50	2	3500	213T	230/460	60	3	18/9
Enclosure	IP	Ins. Class	S.F.	Duty	Nom. Eff.	Nema Design	kVA Code	Ambient Temp. (°C)
TEFC	55	F (*)	1.15	CONT	89.5	B	H	40 C
Locked Rotor Amps	Rotor Inertia (lb-ft ²)	Torque						
		Full Load (lb-ft)	Locked Rotor (%)	Pull Up (%)	Break Down (%)			
60.0	0.46	11.3	230.0	215.0	320.0			

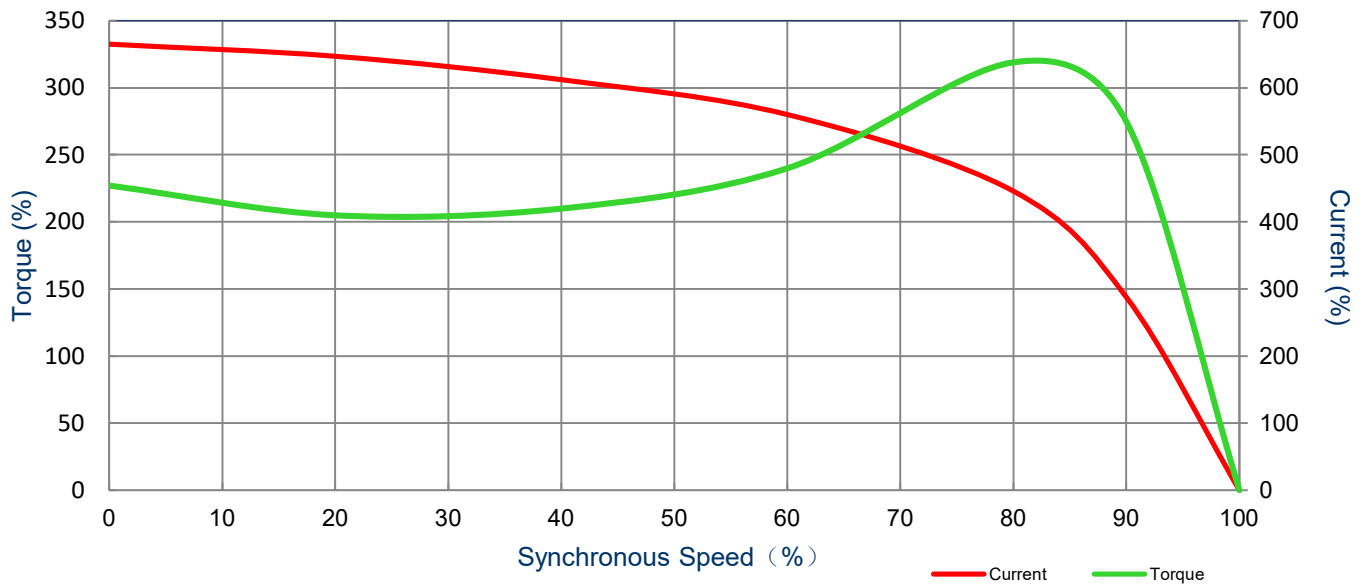

All characteristics are average expected values.

Engineering	Doc. Written By	Doc.# / Rev	MNET07X52A2TBR
Engr. Date	Doc. Approved By	Doc. Issued	



TYPICAL MOTOR PERFORMANCE DATA

Model: MNET07X52A2TBR

Serie: NEMA Elite

Issued Date	11/14/2022	Doc. #	382-R0
Issued By	LD	Issued Rev	0

HP	kW	Pole	FL RPM	Frame	Voltage	Hz	Phase	FL Amps
7.50	5.50	2	2860	213T	190/380	50	3	22/11.0
Enclosure	IP	Ins. Class	S.F.	Duty	Nom. Eff.	Nema Design	kVA Code	Ambient Temp. (°C)
TEFC	55	F (*)	1.0	CONT	86.5	B	H	40 C

* Inventer Duty

Load	HP	kW	Amperes	Efficiency (%)	Power Factor (%)
Full Load	7.50	5.50	11.0	90.6	86.5
¾ Load	5.63	4.20	8.3	91.3	84.4
½ Load	3.75	2.80	5.8	90.8	78.5
¼ Load	1.88	1.40	3.8	80.5	68.1
No Load			2.4		8.4
Locked Rotor			75.0		49.5

Torque				Rotor Inertia (lb-ft²)
Full Load (lb-ft)	Locked Rotor (% FLT)	Pull Up (% FLT)	Break Down (% FLT)	
13.80	155.0	145.0	215.0	0.46

Safe Stall Time(s) Cold / Hot	Sound Pressure dB(A) @ 1M	Bearings*		Approx. Motor Weight (lbs)
		DE	NDE	
14 / 6	-	6308ZZC3	6308ZZC3	168

*Bearings are the only recommended spare part(s).

Included Accessories:

All characteristics are average expected values.

Engineering		Doc. Written By		Doc.# / Rev	MNET07X52A2TBR
Engr. Date		Doc. Approved By		Doc. Issued	



SPEED TORQUE/CURRENT CURVE

Model: MNET07X52A2TBR

Serie: NEMA Elite

Issued Date	11/14/2022	Doc. #	382-R0
Issued By	LD	Issued Rev	0

HP	kW	Pole	FL RPM	Frame	Voltage	Hz	Phase	FL Amps
7.50	5.5	2	2860	213T	190/380	50	3	22/11.0
Enclosure	IP	Ins. Class	S.F.	Duty	Nom. Eff.	Nema Design	kVA Code	Ambient Temp. (°C)
TEFC	55	F (*)	1.0	CONT	86.5	B	H	40 C
Locked Rotor Amps	Rotor Inertia (Kg-m2)	Torque						
		Full Load (lb-ft)	Locked Rotor (%)	Pull Up (%)	Break Down (%)			
75.0	0.46	13.8	155.0	145.0	215.0			

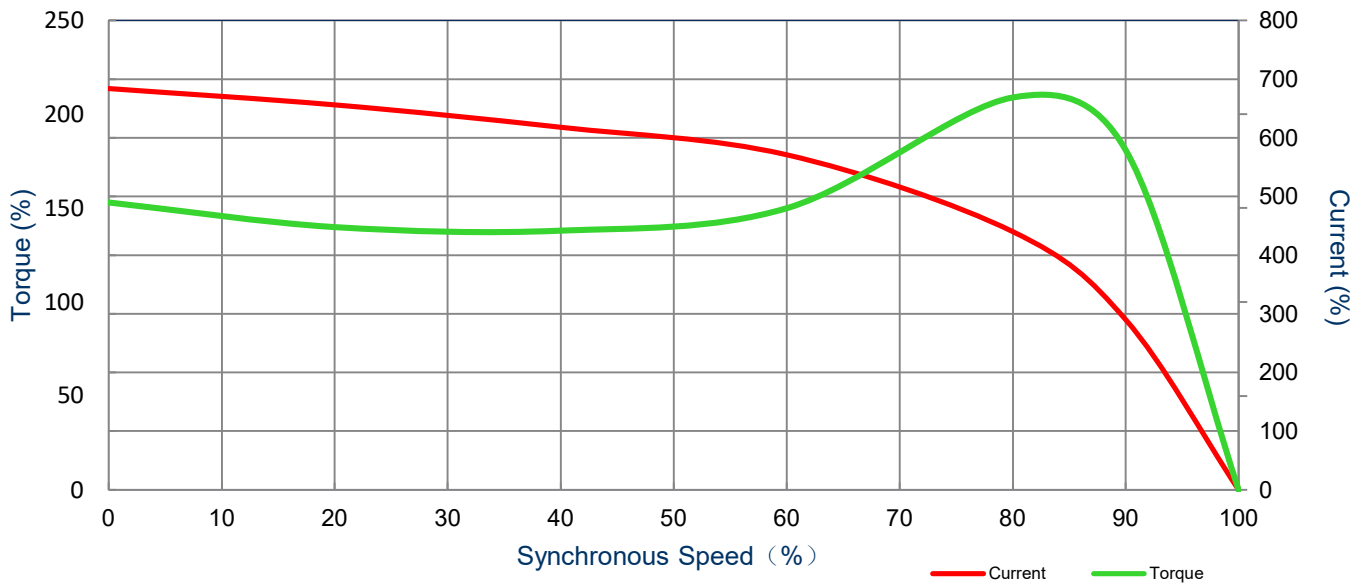

All characteristics are average expected values.

Engineering	Doc. Written By	Doc.# / Rev	MNET07X52A2TBR
Engr. Date	Doc. Approved By	Doc. Issued	

Motor Connection Diagram

Model: MNET07X52A2TBR

Serie: NEMA Elite

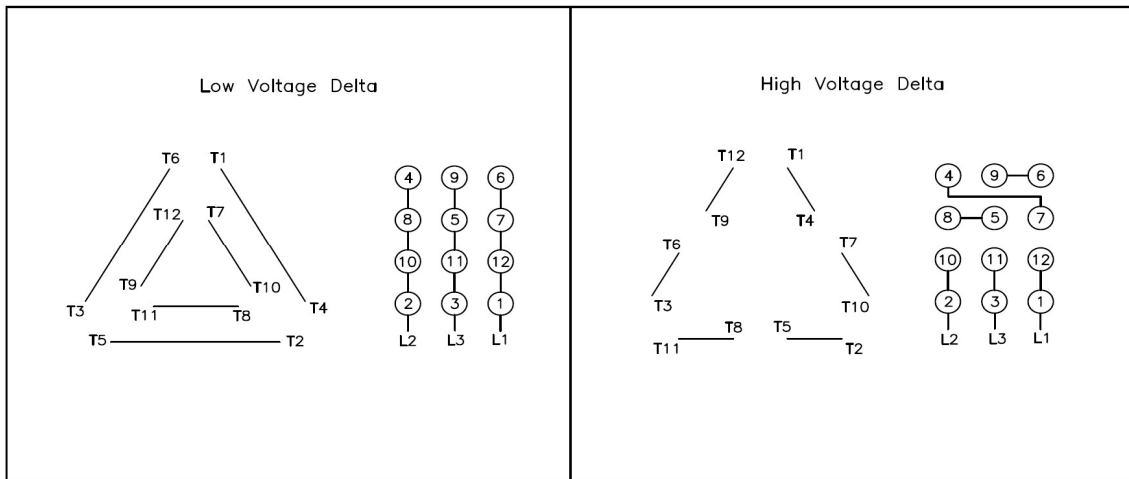

12 Leads Connection Diagram

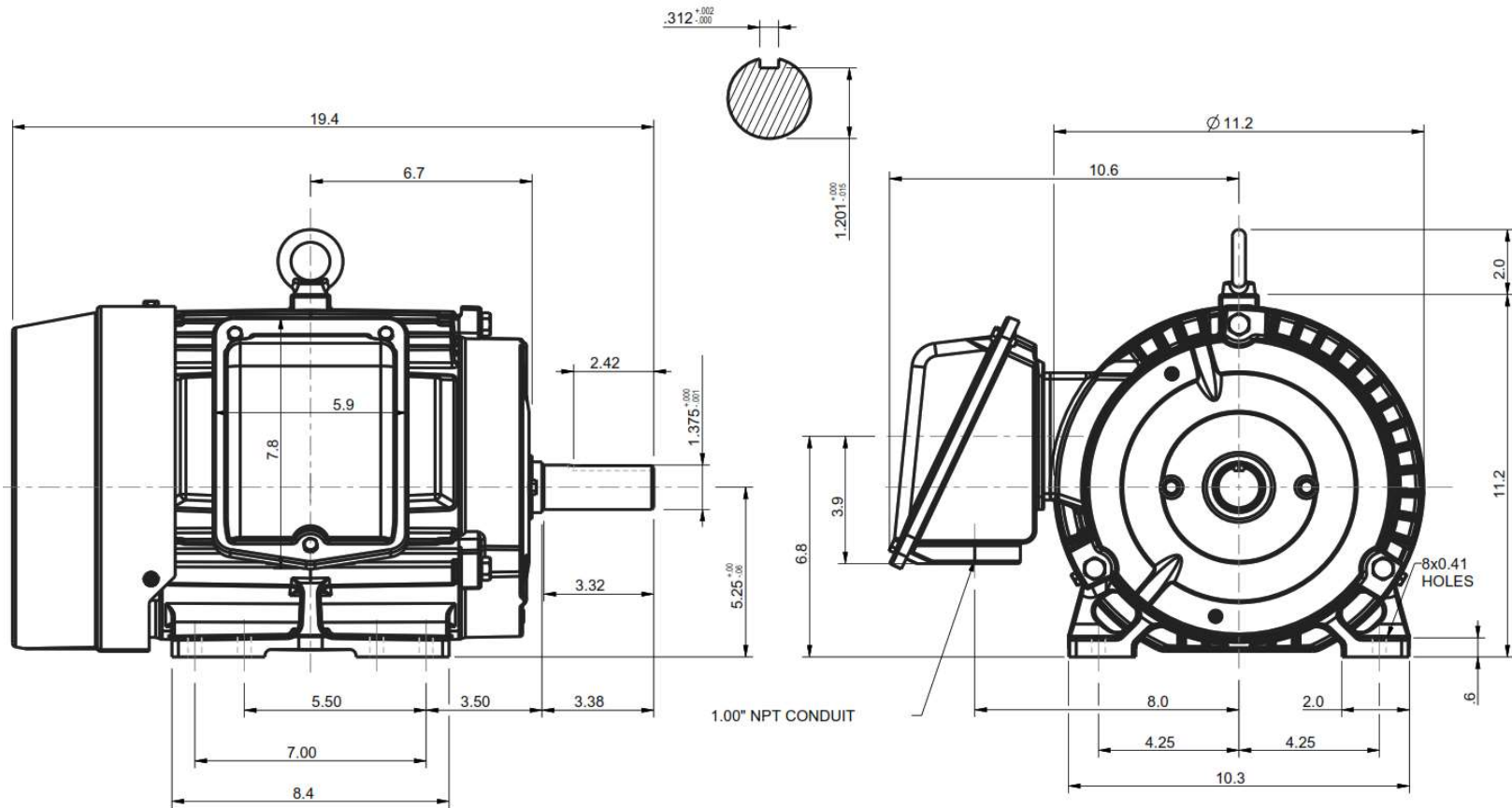

All characteristics are average expected values.

Engineering		Doc. Written By		Doc.# / Rev	MNET07X52A2TBR
Engr. Date		Doc. Approved By		Doc. Issued	



Units: inches		PROPRIETARY INFORMATION We reserve all rights in this document and in the information contained therein. Reproduction, use or disclosure to third parties without express authorization is strictly forbidden. Offenders will be held liable for payment of damages.	Notes:			
ROTATION FROM NDE			1. MAIN CONDUIT BOX MAY BE ROTATED IN 90 DEGREE INCREMENTS			
CCW	CW		2. STANDARD PRODUCT USES BI-DIRECTIONAL FAN. OPPOSITE ROTATION AVAILABLE ONLY BY CONNECTION CHANGE.			
 X						
TASHIDA RESERVES THE RIGHT TO MAKE CHANGES OF TECHNICAL IMPROVEMENT AND THE DATA MAY CHANGE WITHOUT NOTICE				PRELIMINARY		
DO NOT USE FOR CONSTRUCTION, INSTALLATION, OR APPLICATION PURPOSES UNLESS THE DRAWING IS MARKED AS CERTIFIED			X	CERTIFIED		
		TOTALLY ENCLOSED FAN COOLED HORIZONTAL FOOT MOUNTED 3 PHASE INDUCTION MOTOR	Drawing #: MNET07X52A2TBR			
			Rev. Date:	11/14/2022	Rev. #:	0
			Standard:	NEMA	Mount.:	F1
			Frame	213T-215T	Per.:	LD